

# High Voltage Fuse - LC HEV

## Rated 450 V DC

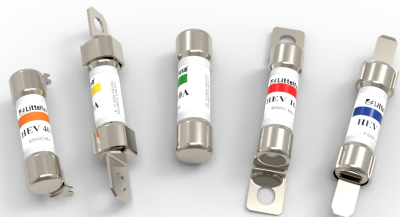

Low Current HEV Fuses

### Specifications

<b>Voltage Rating (10 A, 15 A, 20 A, 30 A):</b>	450 V DC
<b>Voltage Rating (40 A):</b>	425 V DC
<b>Interrupting Rating (10 A, 15 A, 20 A, 30 A):</b>	10 kA @ 450 V DC
<b>Interrupting Rating (40 A):</b>	10 kA @ 425 V DC
<b>Operating Temperature Range:</b>	-40 °C to +125 °C

\*Note: The 0HEV040.ZXBD is rated at 450 V dc.

### Features & Benefits

- Available with blade, bolt down, or PCB connectors
- Available as a cartridge fuse

### Description

LC HEV fuses come in six configurations. Each version of the cylindrical high-voltage fuse protects circuits in EVs and hybrid passenger vehicles. Ask Littelfuse which configuration best meets your needs.

### Applications

- EVs
- Hybrid vehicles





### Ordering Information

Part Number	Termination	Package Size
0HEVxxx.ZXC	Cartridge	240
0HEVxxx.ZXISO	Bolt Down (ISO)	240
0HEVxxx.ZXPY	Blade	240
0HEVxxx.ZXBD	Bolt Down (Axial)	240
0HEVxxx.ZXPCB	PCB Mount	240
0HEVxxx.ZXPCBL	PCB Mount (Long)	240

# High Voltage Fuse - LC HEV

## Rated 450 V DC

### Ratings

Part Number	Current Rating (A)	Color Code	Typical Voltage Drop at 70% I <sub>R</sub> (mV)	Maximum Voltage Drop Spec at 100% I <sub>R</sub> (mV)	Typical Cold Resistance (mΩ)	Minimum Melting I <sup>2</sup> t (A <sup>2</sup> s)
0HEV010.xxx	10		114	300	12.8	255
0HEV015.xxx	15		96	200	7.9	133
0HEV020.xxx	20		79	200	5.0	268
0HEV030.xxx	30		67	200	2.7	993
0HEV040.xxx	40		69	200	2.0	1495

The typical I<sup>2</sup>t is an average value calculated from the breaking capacity tests by using the melting time before the arcing occurs.

### Dimensions

Dimensions in mm

ZXC Cartridge

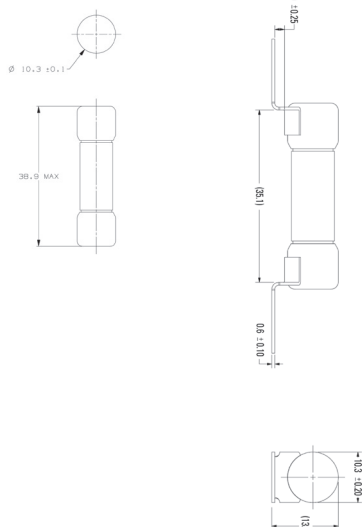

ZXISO Bolt Down (ISO)

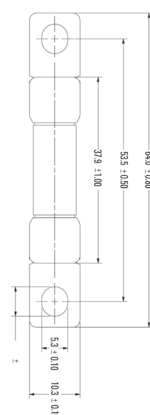

ZXPY Blade

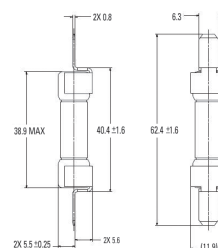

ZXBD Bolt Down (Axial)

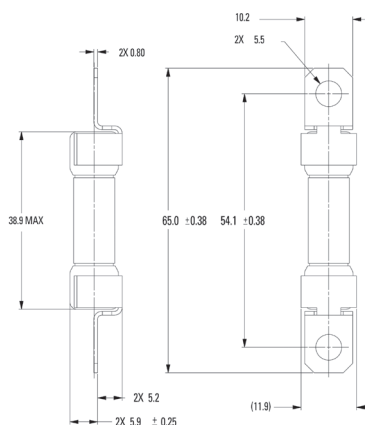

ZXPCB PCB Mount

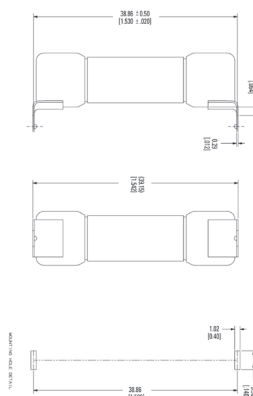

ZXPCL PCB Mount (Long)

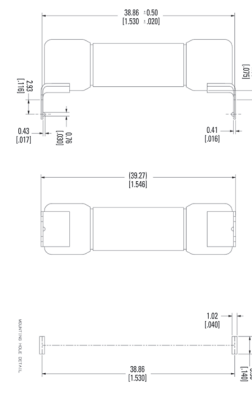

# High Voltage Fuse - LC HEV

## Rated 450 V DC

### Time-Current Characteristic Curves

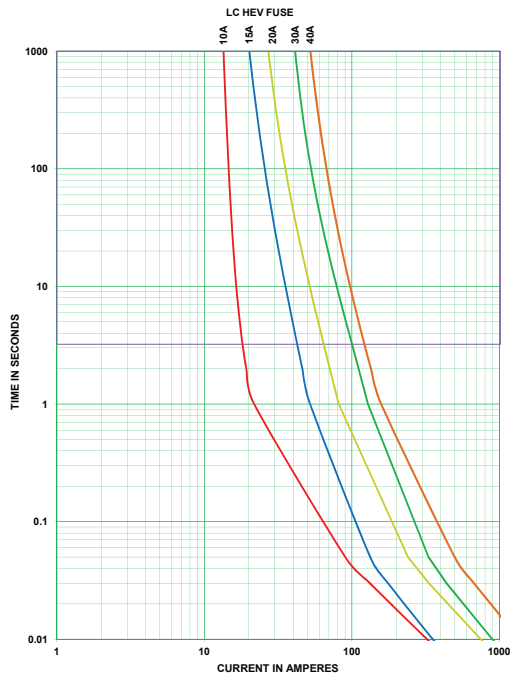

### Time-Current Characteristics

% of Rating	Opening Time	Opening Time	Opening Time
	Min. / Max. (s) 10 A	Min. / Max. (s) 15 A, 20 A, 30 A	Min. / Max. (s) 40 A
100	100 hrs / -	100 hrs / -	100 hrs / -
110	4 hrs / -	4 hrs / -	-
135	100 / 3600	150 / 3600	150 / 3600
150	10 / 1000	10 / 1000	10 / 1000
200	0.5 / 100	0.5 / 100	0.5 / 100
300	0.1 / 15	0.1 / 15	0.1 / 15
500	0.05 / 1	0.05 / 1	0.05 / 1

### Typical Derating Curve

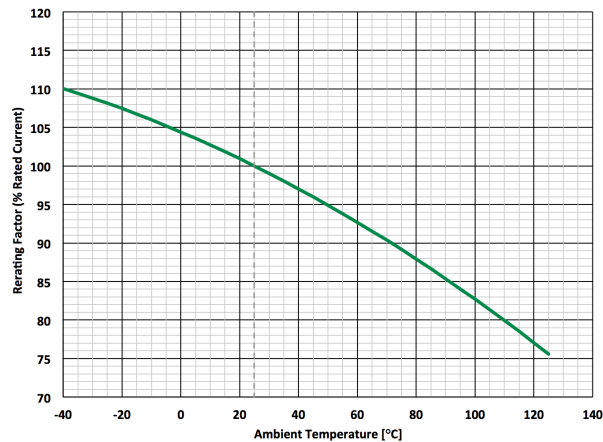

Derating curves may change depending on the final condition of the application (terminals characteristics, wire size etc.). Please ask Littelfuse for more information.